

Apr.1.2017 Copyright 2017 HIROSE ELECTRIC CO., LTD. All Rights Reserved.

COUNT	DESCRIPTION OF REVISIONS	BY	CHKD	DATE	COUNT	DESCRIPTION OF REVISIONS	BY	CHKD	DATE

RECOMMENDED PATTERN

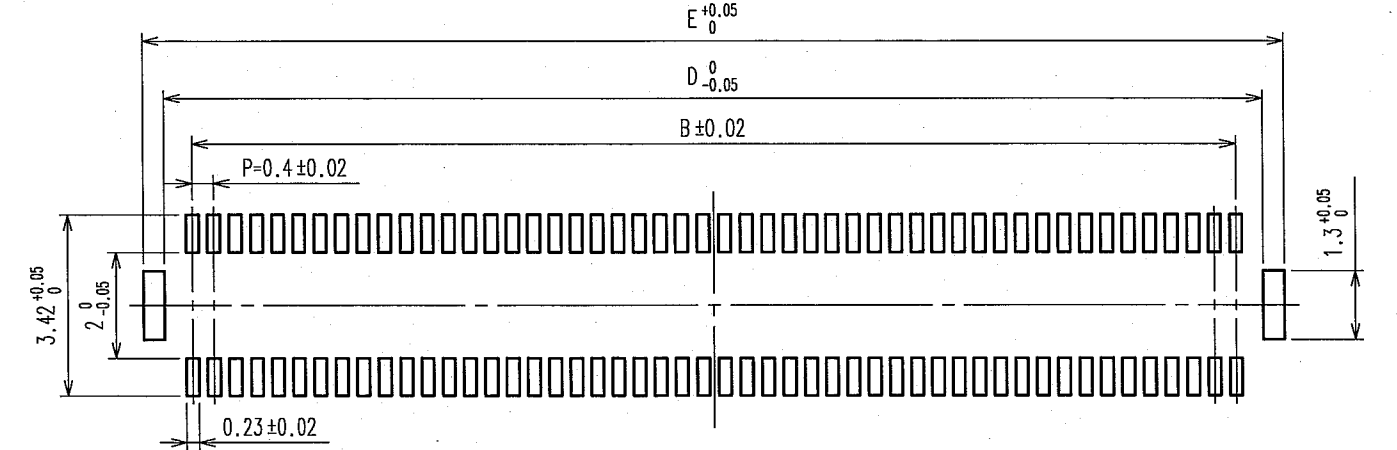

RECOMMENDED SOLDER PASTE THICKNESS: 120μ m

RECOMMENDED METAL MASK OPENING DIMENSIONS FOR LEAD PAD (20:1)

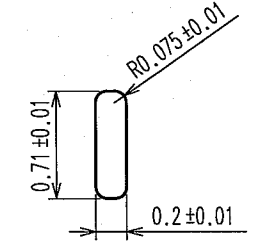

ENGAGEMENT FIGURE(20:1)

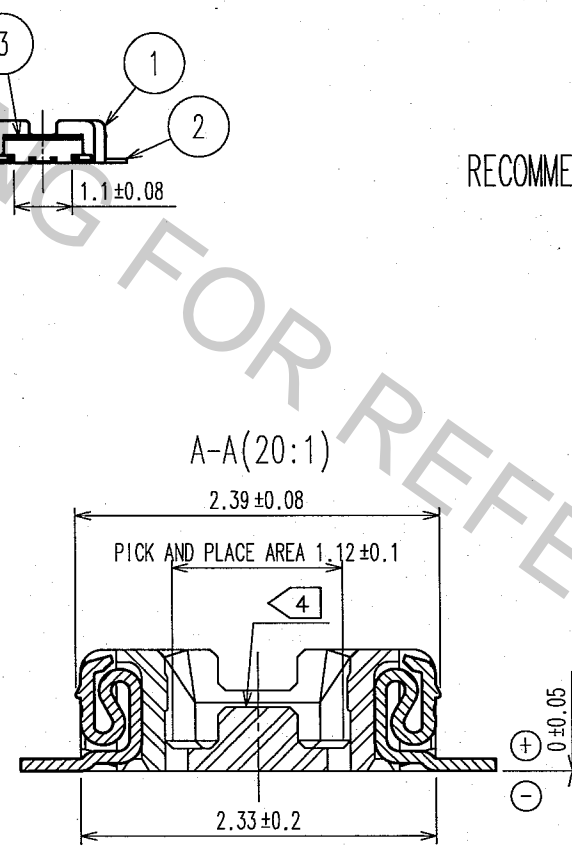
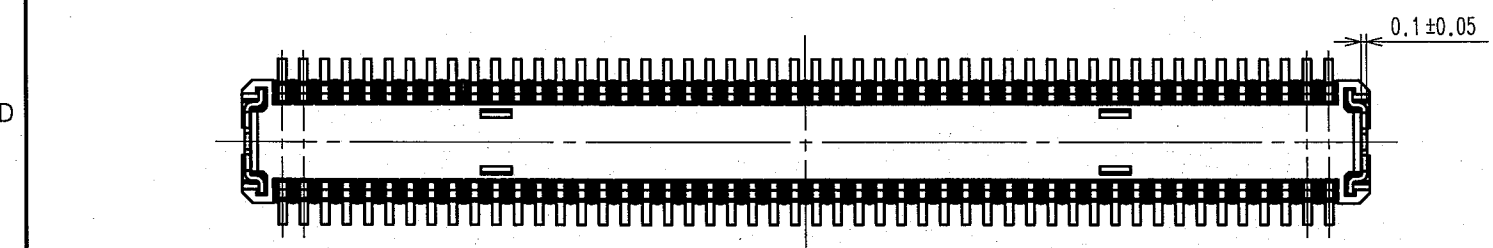
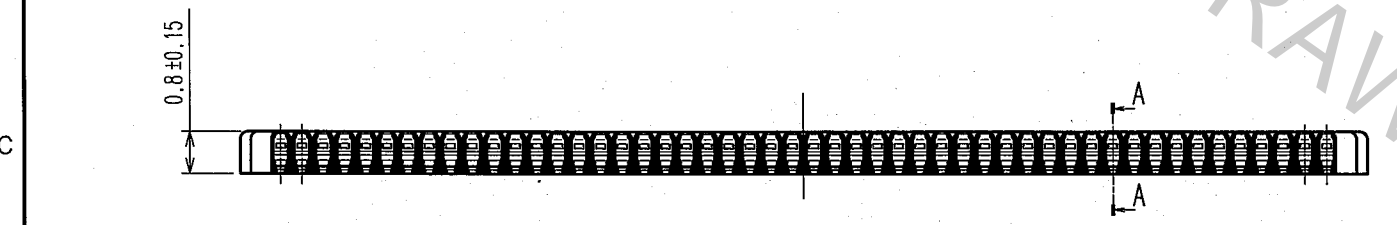
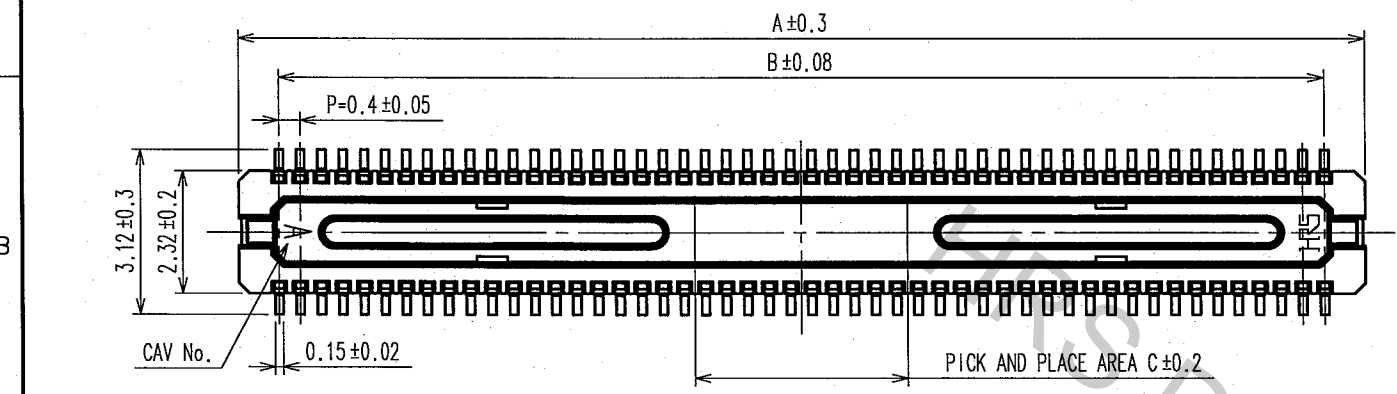
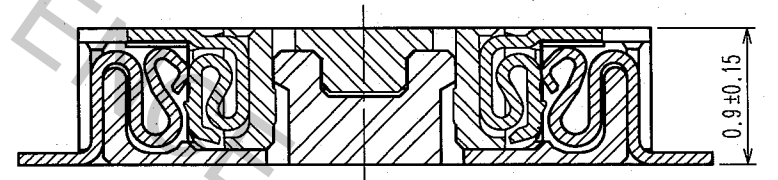

- NOTE 1. ALL LEADS CO-PLANARITY SHALL BE 0.1 MAX.  
 2. PER REEL : 5000 CONNECTORS.  
 3. AT THE BEGINNING OF THE REEL, 100 mm AT MIN SHALL BE EMPTY POCKETS.  
 AT THE END OF THE REEL, 160 mm AT MIN SHALL BE EMPTY POCKETS.  
 4 NO CAVITY ON THE CONNECTORS LESS THAN 24 POS.  
 5 CONTACT PLATING SPECIFICATIONS.  
 CONTACT AREA : GOLD 0.05μ m MIN.  
 SMT LEAD : GOLD 0.02μ m MIN.  
 UNDERPLATING : NICKEL 1μ m MIN.  
 (SURFACE : SEALING)  
 6 METAL HOLD DOWN PLATING SPECIFICATIONS.  
 MOUNTING AREA: TIN 1μ m MIN.  
 UNDERPLATING : NICKEL 1μ m MIN.

PART NO.	CODE NO.	A	B	C	D	E
DF30RB-80DP-0.4V(81)	CL684-1289-1-81	17.14	15.6	3.2	16.64	17.44
DF30RB-70DP-0.4V(81)	CL684-1288-9-81	15.14	13.6	2.8	14.64	15.44
DF30RB-60DP-0.4V(81)	CL684-1287-6-81	13.14	11.6	2.4	12.64	13.44
DF30RB-50DP-0.4V(81)	CL684-1286-3-81	11.14	9.6	2.0	10.64	11.44
DF30RB-40DP-0.4V(81)	CL684-1284-8-81	9.14	7.6	1.6	8.64	9.44
DF30RB-34DP-0.4V(81)	CL684-1283-5-81	7.94	6.4	1.36	7.44	8.24
DF30RB-30DP-0.4V(81)	CL684-1282-2-81	7.14	5.6	1.2	6.64	7.44
DF30RB-24DP-0.4V(81)	CL684-1281-0-81	5.94	4.4	1.2	5.44	6.24
DF30RB-22DP-0.4V(81)	CL684-1280-7-81	5.54	4.0	1.2	5.04	5.84
DF30RB-20DP-0.4V(81)	CL684-1279-8-81	5.14	3.6	1.2	4.64	5.44

3	PHOSPHOR BRONZE	6	PS	PLASTIC REEL (BLACK)		
2	PHOSPHOR BRONZE	5	POLYESTER	CLEAR(COVER TAPE)		
1	LCP	UL94V-0, BLACK	4	PS	CLEAR(EMBOSSED CARRIER TAPE)	
NO.	MATERIAL	FINISH, REMARKS	NO.	MATERIAL	FINISH, REMARKS	
CODE NO. (OLD)		DRAWN	DESIGNED	CHECKED	APPROVED	RELEASED
SCALE		T.ARAI	T. Arai	T. Miyajima	K. Akeda	
UNITS		'06.08.04	'06.08.04	'06.08.04	'06.08.05	
DRAWING NO.		PART NO.		CODE NO.		
FREE		EDC3-312967-01		DF30RB-*DP-0.4V(81)		
mm		HRS HIROSE ELECTRIC CO., LTD		CL684-*****-81		

TO

Apr.1.2017 Copyright 2017 HIROSE ELECTRIC CO., LTD. All Rights Reserved.

1	2	3	4	5	6	7	8		
COUNT	DESCRIPTION OF REVISIONS	BY	CHKD	DATE	COUNT	DESCRIPTION OF REVISIONS	BY	CHKD	DATE

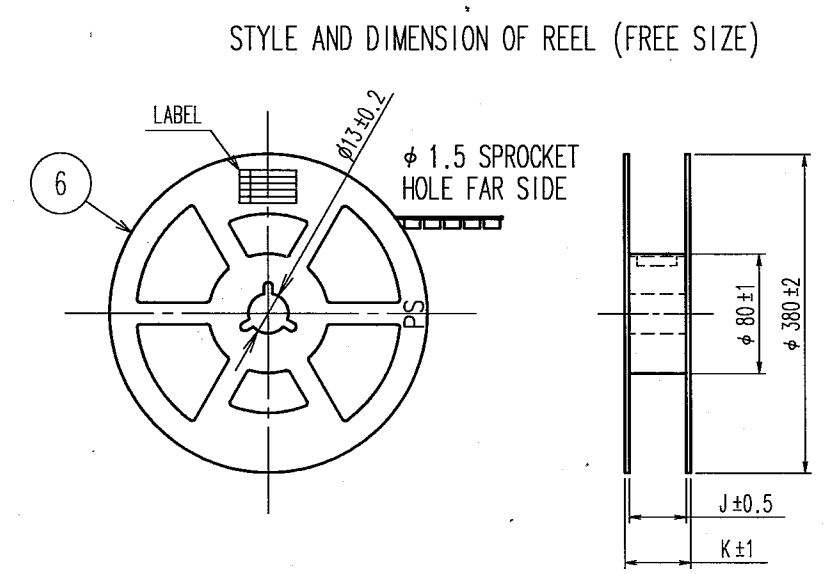
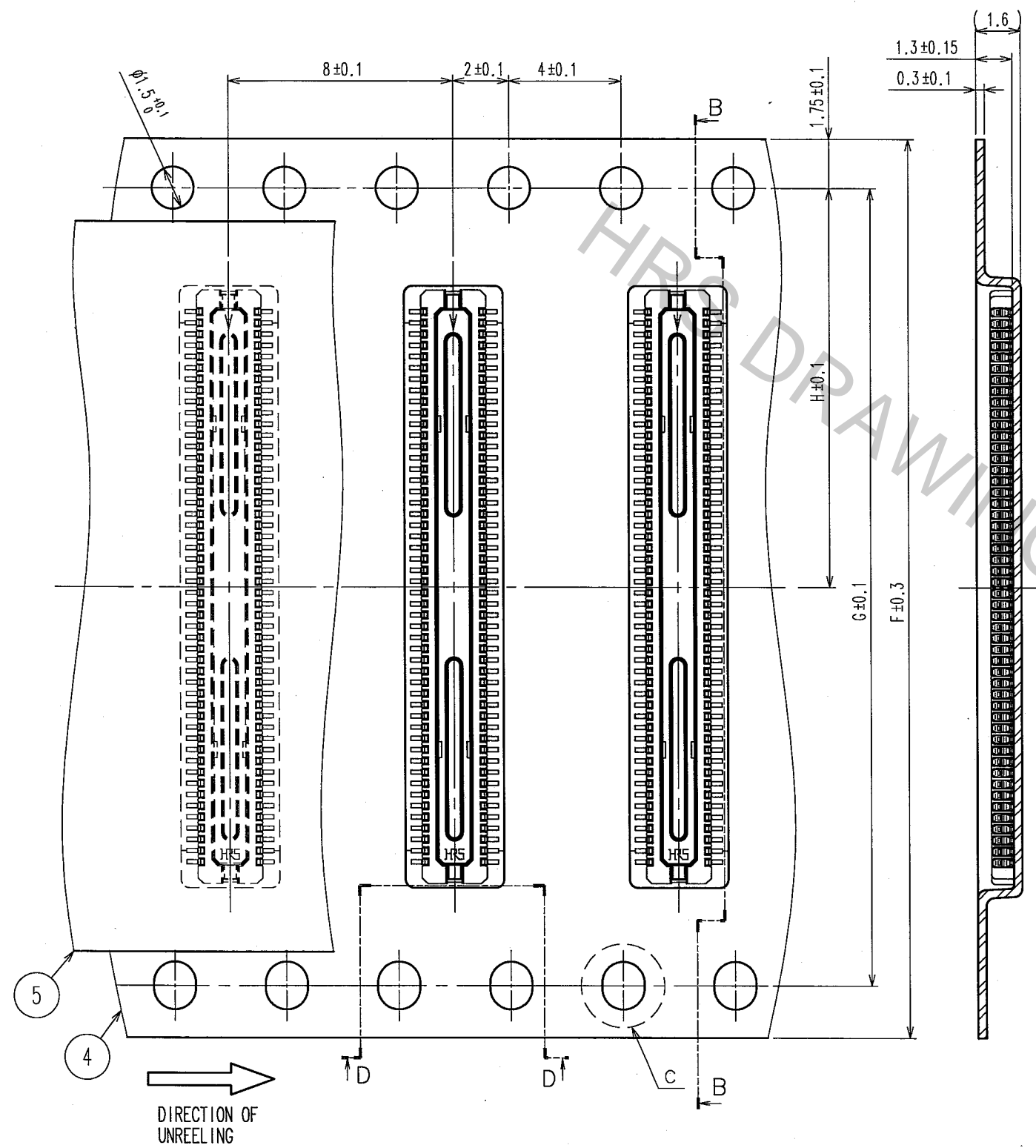

DETAIL OF PART NO. LABEL

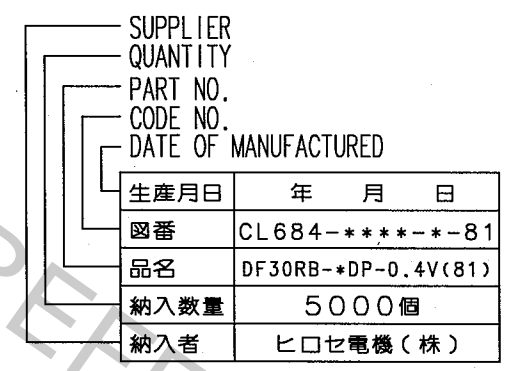

PART NO.	CODE NO.	F	G	H	J	K
DF30RB-80DP-0.4V(81)	CL684-1289-1-81	24	-	11.5	25.5	29.5
DF30RB-70DP-0.4V(81)	CL684-1288-9-81	24	-	11.5	25.5	29.5
DF30RB-60DP-0.4V(81)	CL684-1287-6-81	24	-	11.5	25.5	29.5
DF30RB-50DP-0.4V(81)	CL684-1286-3-81	24	-	11.5	25.5	29.5
DF30RB-40DP-0.4V(81)	CL684-1284-8-81	16	-	7.5	17.5	21.5
DF30RB-34DP-0.4V(81)	CL684-1283-5-81	16	-	7.5	17.5	21.5
DF30RB-30DP-0.4V(81)	CL684-1282-2-81	16	-	7.5	17.5	21.5
DF30RB-24DP-0.4V(81)	CL684-1281-0-81	16	-	7.5	17.5	21.5
DF30RB-22DP-0.4V(81)	CL684-1280-7-81	16	-	7.5	17.5	21.5
DF30RB-20DP-0.4V(81)	CL684-1279-8-81	16	-	7.5	17.5	21.5

TO

CODE NO. (OLD)	DRAWN T.ARAI '06.08.04	DESIGNED <i>T. Arai</i> '06.08.04	CHECKED <i>T. Miyajima</i> '06.08.04	APPROVED <i>K. Akeda</i> '06.08.05	RELEASED
DRAWING NO. EDC3-312967-01	PART NO. DF30RB- <i>*DP</i> -0.4V(81)		CODE NO. CL684-*****-81		
SCALE 5 : 1	UNITS mm		HRS HIROSE ELECTRIC CO., LTD		

1	2		3		4				
COUNT	DESCRIPTION OF REVISIONS	BY	CHKD	DATE	COUNT	DESCRIPTION OF REVISIONS	BY	CHKD	DATE
△	4	RE-H-06664	YM	TS	04.12.17	△			. .
△						△			. .
△						△			. .

■ NOTES WHEN MATING DF30 SERIES CONNECTORS.

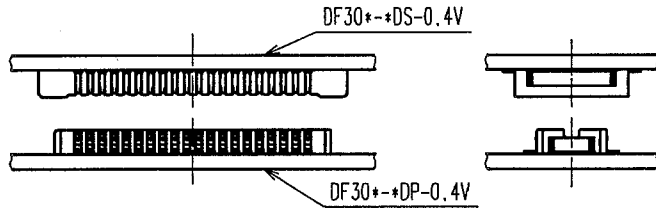

FIGURE-1

PLEASE LOCATE EACH CONNECTOR IN PARALLEL WHEN YOU PUT THEM IN MATING POSITION.

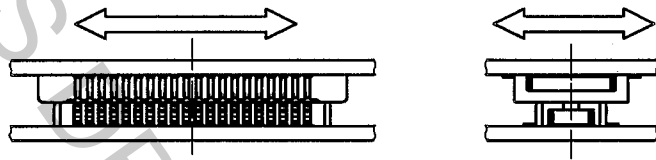

FIGURE-2

THE INSULATOR WILL BE DAMAGED AND THE CONTACTS WILL BE DEFORMED IF THE CONNECTORS ARE LOCATED INCLINED AND MATED BY EXCESSIVE FORCE.

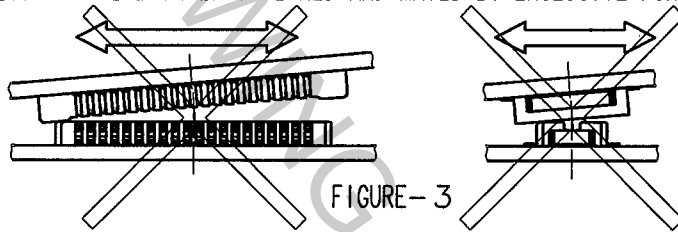

FIGURE-3

WHEN YOU LOCATE TWO CONNECTORS IN A PROPER POSITION, THEY WILL GO DOWN SLIGHTLY AT A LOWER LEVEL AND YOU WILL FIND THAT THEY GET LOCATED CORRECTLY. PLEASE MATE EACH CONNECTOR IN PARALLEL AFTER YOU CONFIRMED THAT THEY GO DOWN LOWER TO SOME EXTENT.

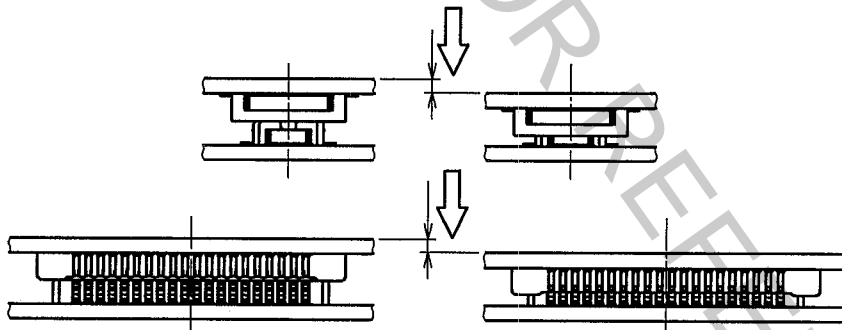

FIGURE-4

THE MATED CONDITIONS CAN BE RELEASED BY A DROP IMPACT OR THE APPLIED FORCE CAUSED BY FPC-HANDLING. FIX THE CONNECTORS BY APPLYING PRESSURE IN THE MATING DIRECTION WITH THE DEVICE OR A BUFFER MATERIAL.

CODE NO. (OLD)		DRAWN Y. MICHIDA 04.12.16	DESIGNED A. TAKAHASHI 04.12.16	CHECKED T. SAKATA 04.12.16	APPROVED T. OMA 04.12.16	RELEASED
NOTES WHEN MATING		DRAWING NO. EDSC4-830174		PART NO. DF30 Series		
SCALE FREE : 1		UNITS mm		CODE NO. CL684		1/3
HRS HIROSE ELECTRIC CO., LTD.						

Apr.1.2017 Copyright 2017 HIROSE ELECTRIC CO., LTD. All Rights Reserved.

TO



1			2			3			4					
COUNT	DESCRIPTION OF REVISIONS	BY	CHKD	DATE	COUNT	DESCRIPTION OF REVISIONS	BY	CHKD	DATE	COUNT	DESCRIPTION OF REVISIONS	BY	CHKD	DATE
△					△									.
△					△									.
△					△									.

■ NOTES WHEN EXTRACTING

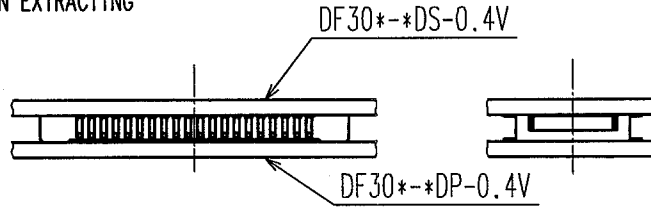

FIGURE-5

WHEN YOU EXTRACT CONNECTORS, PLEASE EXTRACT IN PARALLEL.

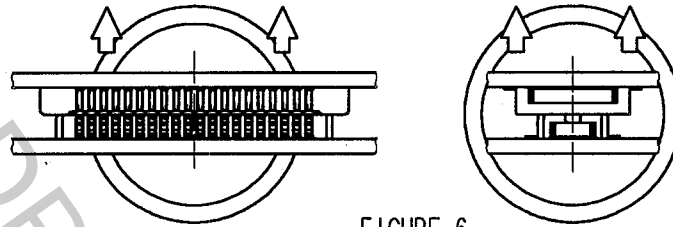

FIGURE-6

⚠ IF YOU'RE UNABLE TO EXTRACT IN PARALLEL DUE TO SET STRUCTURE OR SPACE, PLEASE EXTRACT AS FIGURE-7 (IN LONGER DIMENSION). PLEASE BE CAREFUL NOT TO DAMAGE CONTACTS AT SIDES, WHERE STRESS IS LIKELY TO GATHER WHEN CONNECTORS ARE MOUNTED ON SOFT FPC.

⚠ ESPECIALLY, PLEASE DO NOT EXTRACT FROM THE CORNER AS FIGURE-8. IT GIVES CRITICAL STRESS TO THE CONTACTS ON THE CROSS CORNER.

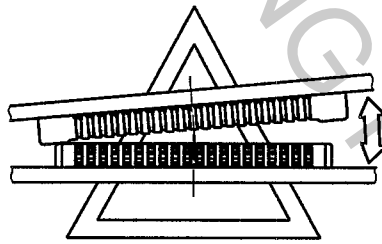

FIGURE-7

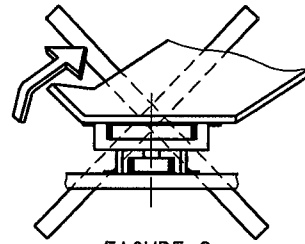

FIGURE-8

⚠ PLEASE DO NOT EXTRACT AS FIGURE-9. THE STRESS CONCENTRATES ON ONE ROW, AND MIGHT DAMAGE CONNECTORS TO MALFUNCTION.

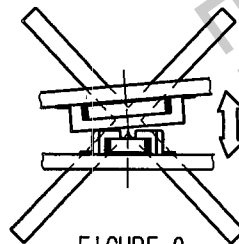

FIGURE-9

CODE NO. (OLD)		DRAWN	DESIGNED	CHECKED	APPROVED	RELEASED
		Y.MICHIDA	A.TAKAHASHI	T.SAKATA	T.OMA	
NOTES WHEN EXTRACTING		04.12.16	04.12.16	04.12.16	04.12.16	
DRAWING NO.		PART NO.				
EDSC4-830174		DF30 Series				
SCALE FREE : 1		CODE NO.				
UNITS mm		CL684				
HRS HIROSE ELECTRIC CO.,LTD.		2/3				

TO



1		2			3			4		
COUNT	DESCRIPTION OF REVISIONS	BY	CHKD	DATE	COUNT	DESCRIPTION OF REVISIONS	BY	CHKD	DATE	
△					△				. .	
△					△				. .	
△					△				. .	

⚠ WHEN FPC IS SOFT, STRESS IS CONCENTRATED ON THE CONTACTS AT CORNERS. PLEASE PAY ATTENTION TO THIS POINT AND DO NOT UNMATE CONNECTORS FROM CORNERS AS FIGURE-10. THIS GIVES SERIOUS DAMAGE ON CONTACTS, AND OCCURS SOLDER PEEL-OFF OR CONTACT COME-OFF.

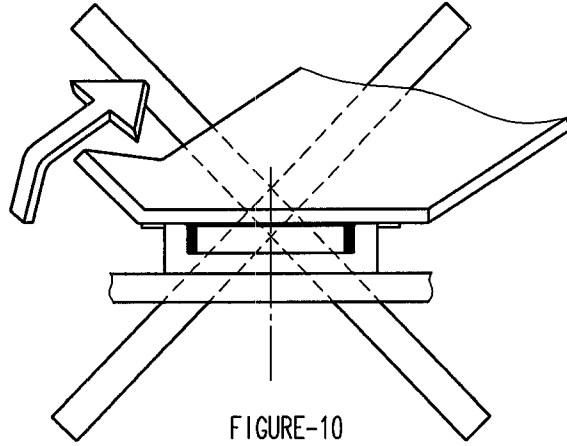

FIGURE-10

IF YOU MOUNT PLUG CONNECTOR ON FPC, CONTACTS MIGHT COME OFF FROM HOUSING MOLD.

CONTACT MIGHT COME OFF FROM HOUSING MOLD.

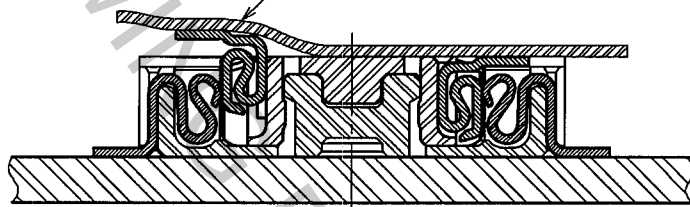

FIGURE-11

IN CASE YOU MOUNT RECEPTACLE CONNECTOR ON FPC, THERE IS NO RISK OF CONTACT COME-OFF. HIROSE RECOMMEND THAT RECEPTACLE IS MOUNTED ON FPC.

IN ORDER TO AVOID THIS RISK, IT IS RECOMMENDED THAT YOU MOUNT RECEPTACLE CONNECTOR ON FPC.

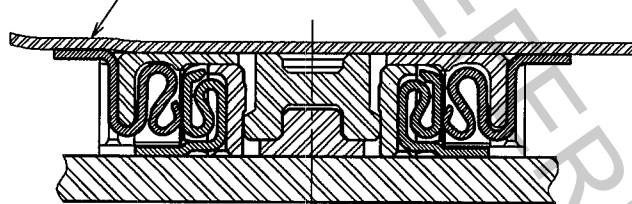
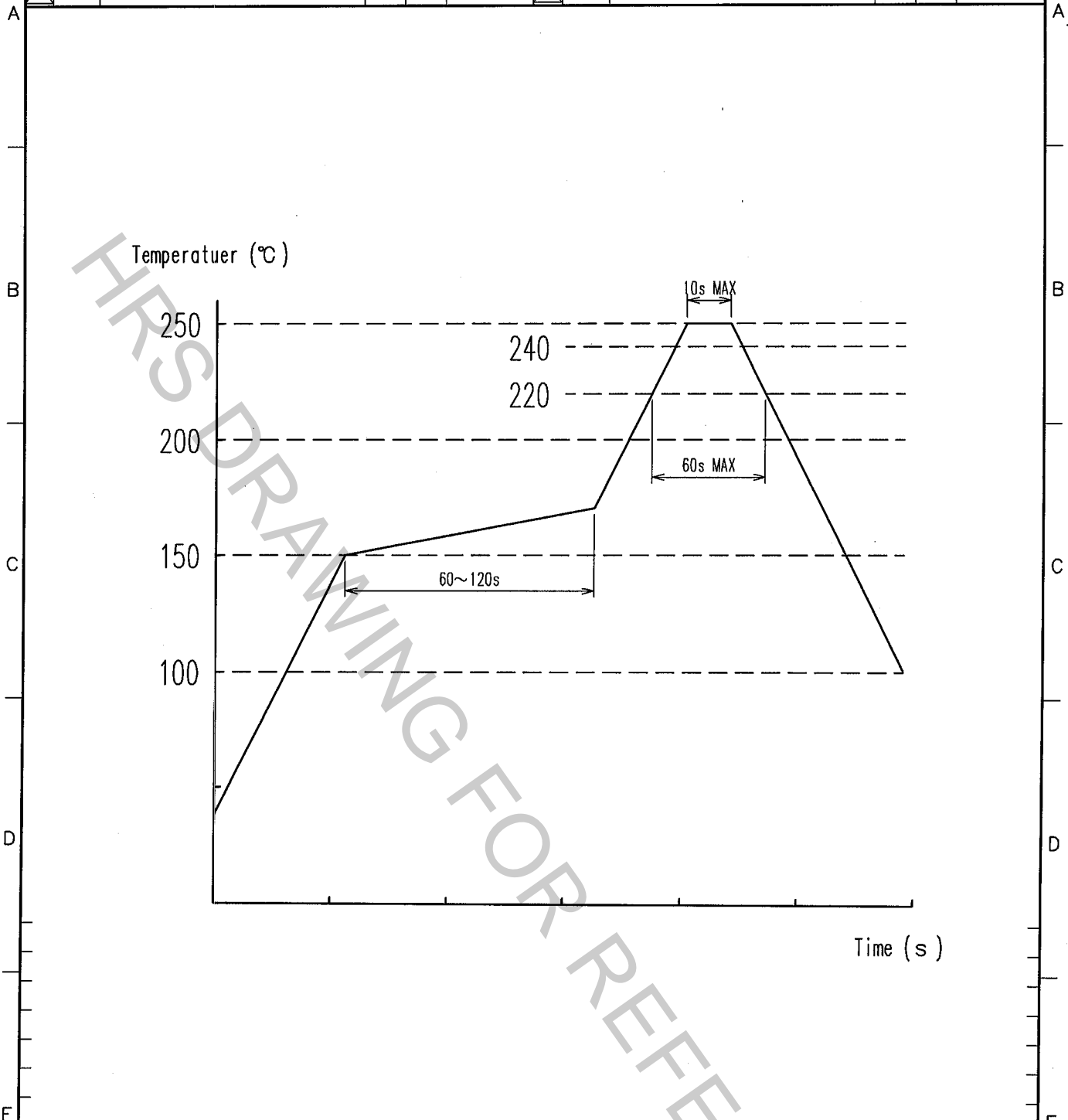

FIGURE-12

CODE NO. (OLD)		DRAWN	DESIGNED	CHECKED	APPROVED	RELEASED
		Y.MICHIDA	A.TAKAHASHI	T.SAKATA	T.OMA	
NOTES WHEN EXTRACTING (SUPPLEMENTARY DATA)		04.12.16	04.12.16	04.12.16	04.12.16	
 SCALE FREE : 1 UNITS mm	DRAWING NO.		PART NO.			
	EDSC4-830174		DF30 Series			
	 HIROSE ELECTRIC CO.,LTD.		CODE NO.		CL684	
						3/3

1			2			3			4					
COUNT	DESCRIPTION OF REVISIONS	BY	CHKD	DATE	COUNT	DESCRIPTION OF REVISIONS	BY	CHKD	DATE	COUNT	DESCRIPTION OF REVISIONS	BY	CHKD	DATE
△					△					△				
△					△					△				
△					△					△				



NOTE 1. REFLOW SYSTEM : IR REFLOW (AIR OR N<sub>2</sub> GAS)  
 2. PERFORMING REFLOW : TWICE MAX

NO.	MATERIAL	FINISH, REMARKS	NO.	MATERIAL	FINISH, REMARKS
CODE NO. (OLD)			DRAWN	DESIGNED	CHECKED
			T. NISHI	W. Fukuchi	J. Yamada
			03.08.19	03.08.19	03.08.20
					APPROVED
					J. Ono
					03.08.20
					RELEASED
DRAWING NO.			PART NO.		
EDC4-830116			DF30-*DS/DP-0.4V		
CODE NO.			CL684		

TO

SCALE  
FREE

UNITS  
mm

**HRS** HIROSE ELECTRIC CO., LTD.

1/1

